

FLOORTECH PVC FABRICATORS

Grease interceptors

Model no: FTF-GI-25

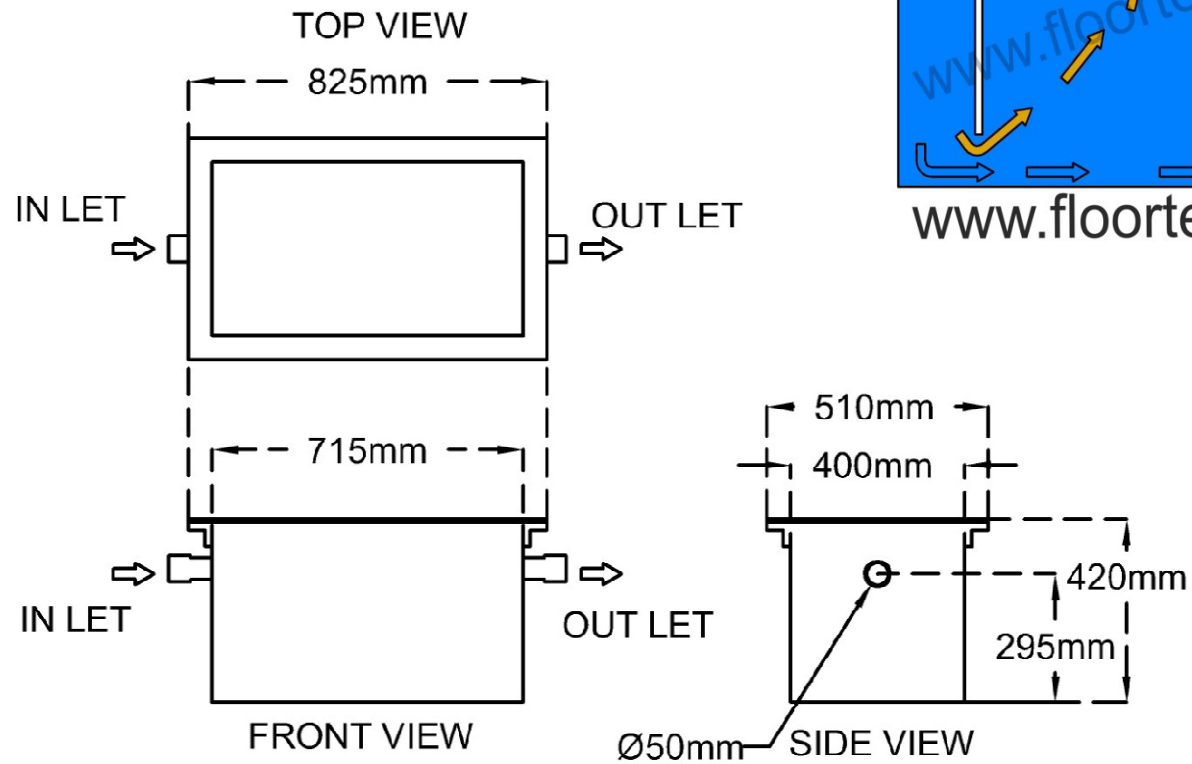

- 2" inch or 50mm diameter inlet and outlet pipe with coupling end is provided.
- With grease interceptor capacity 25 Gallons per Minute (GPM) or 1.57 Liters per Second (LPS) or 94.6 Liters per Minute.
- Since the product is fabricated out of plastic, all the above mentioned dimensions are approximate.